

Z3C PRO

Product Manual 产品说明手册

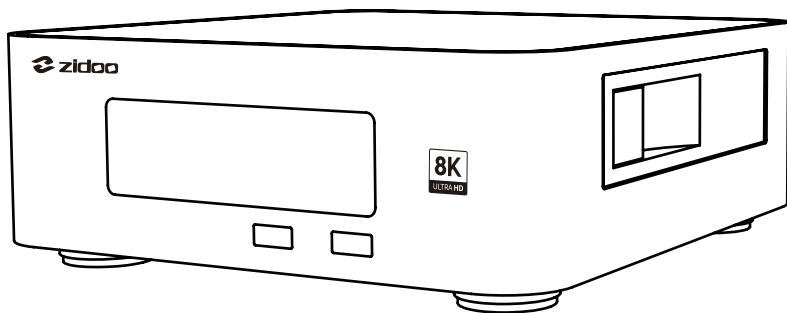

感谢您使用芝杜 ZIDOO 旗下产品，您可以关注我们的社交平台账号，
和我们一起交流与分享。

Thank you for choosing products of ZIDOO. Friend us on Facebook
or X to communicate and share with us.



微信公众号 @ **zidoo**
WeChat Official Account



微博账号 @ 芝杜官方
Weibo Account



Facebook @ **zidootv**



X @ **zidootv**

如需更多帮助，请访问芝杜 ZIDOO 官网的用户论坛进行咨询

If you need more assists, please visit user forum of the official
website of ZIDOO for consultation.



官网网址 /Official website: www.zidoo.tv

目录 / Content

01

配置介绍

接口介绍 P1

性能参数 P3

硬盘装载 P4

设备连接 P5

02

开机初始化向导

P7

03

系统介绍

P12

04

遥控器颜色键功能定义

P21

05

OTA 系统升级

P22

01

Introduction to Hardware

Interfaces P25

Specifications P27

Hard Disk Installation P28

Example Connection P29

02

Boot Initialization Wizard

P31

03

Introduction to System

P36

04

Color Keys Customization

P48

05

OTA System Update

P49

配置介绍

接口介绍

芝杜 Z30 PRO 配备丰富的音视频输入输出接口及数据传输接口。

1. 正面

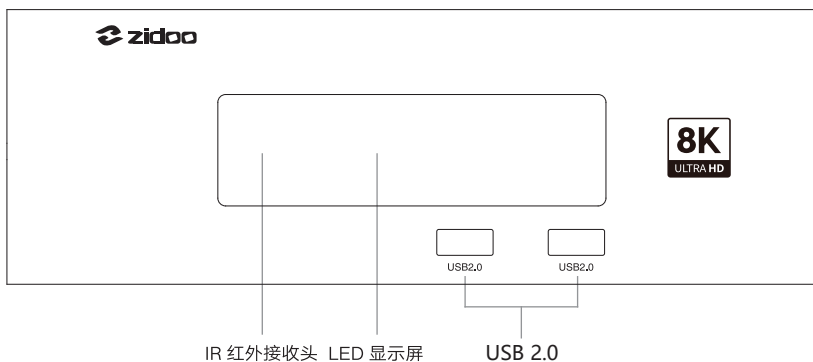

2. 左侧

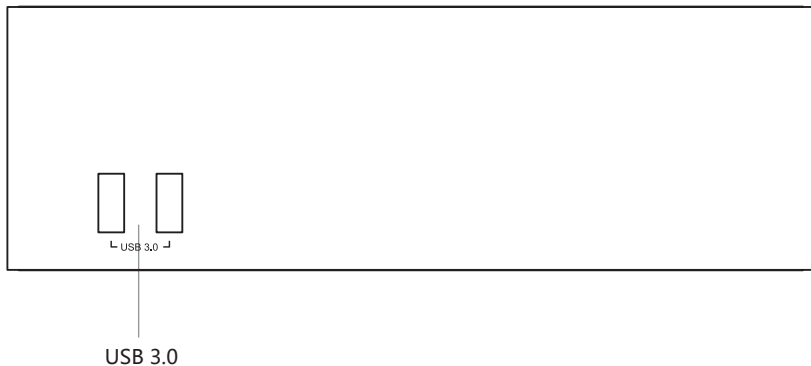

3. 右侧

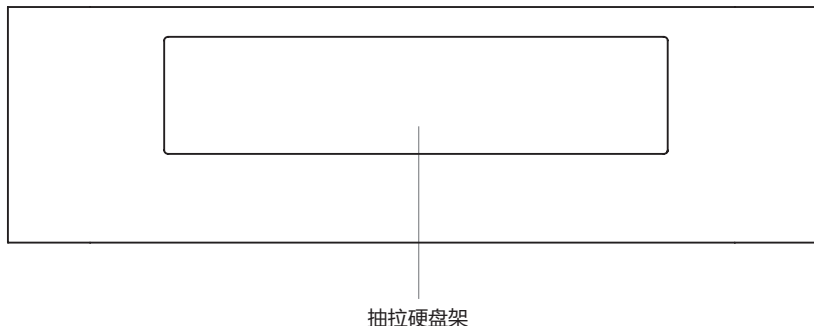

4. 背面

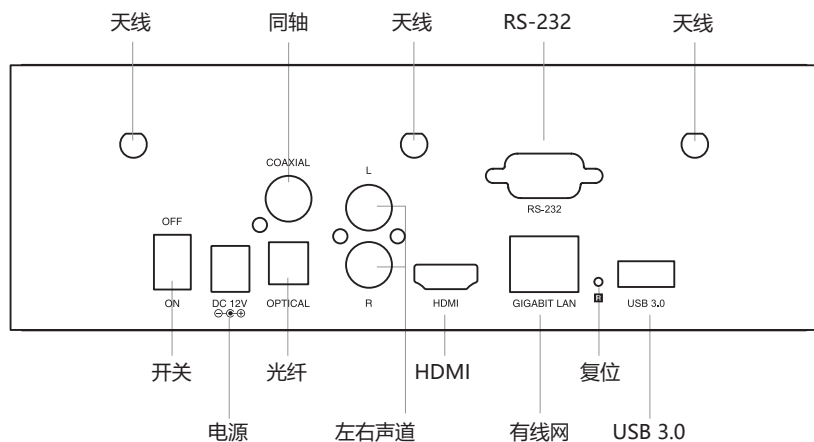

天线安装说明：请将配件中的天线安装至上图所示的天线接口。

注意：

- * 请在断电的状态下装载 \ 更换硬盘，如是全新硬盘，请格式化后装载。
- * 请不要将任何东西遮挡散热风扇孔。
- * 请不要接触液体，以免流入设备内部造成损坏。
- * 非指定维修人员，请不要拆开机壳。

性能参数

前置显示	LED
机身	铝合金
系统	Android 11
CPU	Amlogic S928X-K ARM Cortex-A76+Cortex-A55(四核)
GPU	ARM Mali-G57 MC2
运行内存	6GB DDR4
内部储存	64GB eMMC
蓝牙	BT 5.2
Wi-Fi 6 网络	2.4G+5G 双频 WiFi, 802.11 a/b/g/n/ac/ax 2T2R, 802.11ax MIMO OFDM
以太网网络	1*RJ-45 以太网插孔 (10/100 /1000Mbps)
HDMI 输出	HDMI 2.1a, 最高支持 8K@60p, HDR10+, 12Bit 色深, BT2020 广色域; 支持 HDR10, HDR10+, HLG, 杜比视界; 支持 Dolby Atmos 和 DTS X 音频源码透传
视频解码	8K@60p AV1/VP9/H.265/AVS3/AVS2; HDR10, HDR10+, HLG, 杜比视界
音频解码	支持 Dolby/DTS 格式 (最高支持 Dolby TrueHD Atmos 和 DTS X) 解码
音频输出	USB 输出, 1* 光纤输出、1* 同轴输出、2*RCA 左 / 右声道
智能控制	iPhone/iPad 横屏 / 安卓手机 / 安卓平板横屏, RS-232, TCP/IP 控制 (支持网络唤醒)
SATA	内置 1*SATA 3.0 的 3.5 寸硬盘仓 (不含硬盘)
USB	3*USB 3.0, 2*USB 2.0
电源	DC 12V 2A
其他接口	1* 红外接收头, 1*RS232, 3* 天线

硬盘装载

Z30 PRO 搭载 3.5 寸硬盘仓, 内置 SATA 高速传输接口, 无需借助任何工具, 将硬盘 SATA 接口朝里轻松推入即可装载 (硬盘最大支持 16TB)。

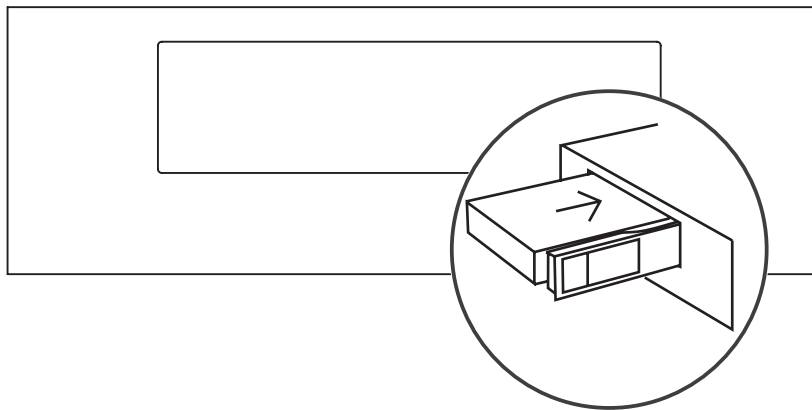

注意: 请勿在设备通电的状态下装载或更换硬盘, 以免造成设备或硬盘数据损坏, 如果是全新硬盘, 请先格式化硬盘再装载至设备, 本机支持硬盘格式为: EXT3、EXT4、NTFS、FAT32、EXFAT。

设备连接

1. HDMI连接电视

① 将设备断电，请务必保证电视机与播放器都在断电的状态下操作。

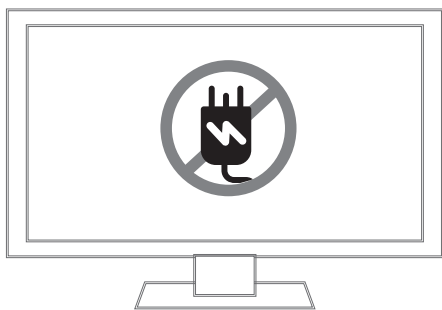

② 在电视机与播放器都断电的情况下，将HDMI线一头插入设备的HDMI接口、另一头插入电视HDMI IN接口；



③ 电源连接，本设备配备 DC 电源适配器，请将 DC 适配器接头连接在本机的 DC 电源输入接口，将 DC 电源线的插头一端接入交流 110~240V 的电源插座。

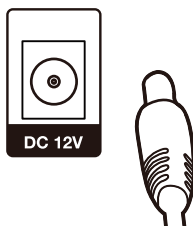

④ 电视选择对应的视频源。

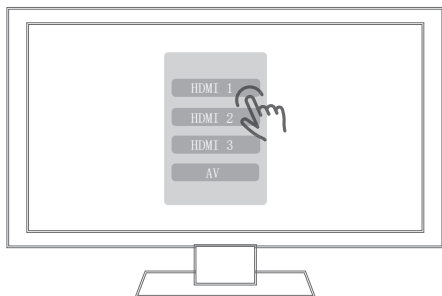

2. 其它连接方式

其它连接方式与 HDMI 线的连接步骤相同，请先将线路连接好再通电。

开机初始化向导

1. 系统语言选择、屏幕缩放、时区设置

按照您的语言习惯选择系统语言；

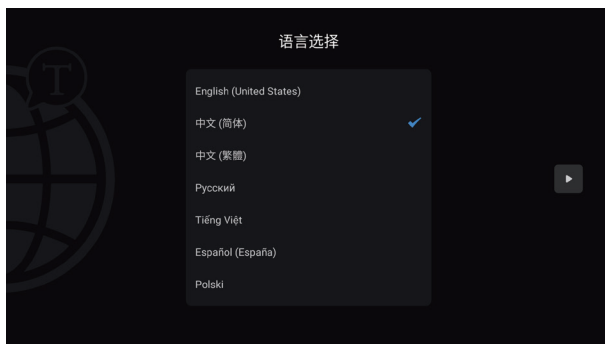

按遥控器上下方向键调节合适的屏幕显示大小；



根据您所处地区选择对应系统显示的时区。



2. 网络设置

请根据具体网络情况设置相关网络配置，让机器快速连接网络。



无线网络 (WIFI)：选择网络 SSID，输入密码，连接 WiFi；

有线网络：只需插入网线即可自动连接网络。

3.设备连接方式

可根据你的影音设备情况选择对应的连接方式。

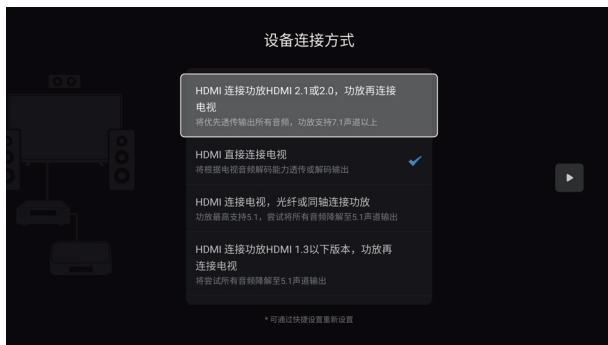

注意：不同的连接方式所呈现的效果也将有不同。

- HDMI 接口连接功放 HDMI 2.1 或 2.0, 功放再连接电视: Z30 PRO 会优先透传输出所有音频, 功放支持 7.1 声道以上。
- HDMI 接口直接连接电视: Z30 PRO 将根据电视音频解码能力透传或解码输出。
- HDMI 接口连接电视, 光纤或同轴连接功放: 功放最高支持 5.1, 并尝试将所有音频降解至 5.1 声道输出。
- HDMI 接口连接功放 HDMI 1.3 以下版本, 功放再连接电视: Z30 PRO 将尝试所有音频降解至 5.1 声道输出。

4. 按键定义

根据您的使用习惯定义遥控器上的数字键、选时键、字幕键、音轨键、上下键、翻页键对应的功能。

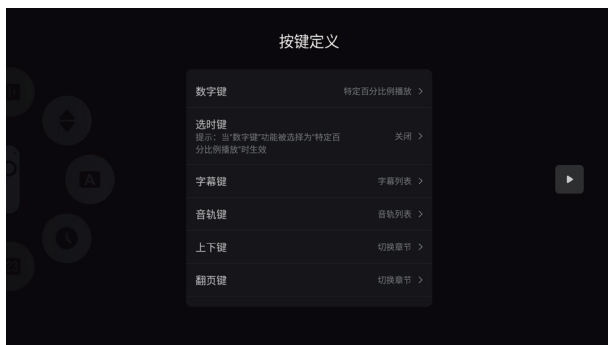

5.手机控制

移动设备可以扫描左侧二维码下载安装芝杜控制 APP，然后启动芝杜控制 APP 扫描右侧二维码与芝杜播放器完成配对。



完成以上设置后，按照提示点“下一步”完成整个设备的初始化设置，接下来就可享受芝杜产品给您带来的视听盛宴。

芝杜控制 APP 可完美适配 Android 与 iOS 系统的手机 / 平板（横屏），可查看海报墙、音乐库的数据及系统应用和菜单，也可通过控制 APP 浏览与播放内置的流媒体服务，为您提供舒适的操控体验。

芝杜控制 APP 支持同屏互动功能，可镜像呈现播放器显示画面并进行各项操控。

芝杜支持纯音乐模式：即使不打开显示设备，也能享受高清无损音乐。

芝杜控制 APP 能够远程开机 / 关机：支持 WOL（网络唤醒）功能，通过有线网络远程控制播放器的开关。

芝杜控制 APP 拥有悬浮按钮功能，您可以通过悬浮的窗口进行各种基础控制功能。

系统介绍

1. 媒体中心

芝杜拥有一套完整的全功能媒体管理系统，既拥有丰富完整的文件管理功能，又可照顾到大屏操作的便利。

- 支持直接访问外部驱动器、支持自动或手动扫描局域网内所有可用的 NFS 或 SMB 网络驱动器，局域网媒体访问更随心；
- 可以对文件进行多选、拷贝、剪切、删除、排序、等诸多管理方式；
- 支持 UPnP 局域网共享协议以及 WebDAV、百度网盘、阿里云盘等多种网盘的挂载和在线播放。

2. 海报墙

芝杜采用全新算法的海报墙影片管理系统，简约扁平化的分类导航界面，大数据个性化的分类，观看记录、类型题材分类、智能推荐等高度可自定义分类展示一目了然，美轮美奂的全新视觉体验。高度可自定义的模块化管理，从此心怡佳作触手可及，大幅提高了收藏的便利性，充分满足玩家对海量影片的管理效率。

添加视频操作指引：

- ① 第一次启动海报墙可以配置语言、儿童锁初始设置，如不需要可略过；
- ② 海报墙首页点击“进入设备管理”；
- ③ 点击“添加设备”，选择一个视频目录（支持添加多个目录），路径支持内外置存储、SMB、NFS 等；
- ④ 配置扫描选项后，点击开始扫描，等待海报墙加载完成即可。

注意：海报墙刮削源建议使用智能。

3. 音乐播放器

Z30 PRO 音乐播放器提供强大的本地音乐播放性能，还提供了完整本地音乐库管理功能，可以跨平台添加本地硬盘或者网络存储器的音乐文件，音乐播放器将自动获取音乐信息，匹配音乐艺术家，专辑封面简介、本地 CUE 文件等信息，为我们构造一个专属音乐资料库；支持音乐的流派、采样率、专辑、艺术家等个性化的分类展示；支持新建喜爱歌单，专辑、艺术家、歌曲首字母快捷找歌等功能。不论音乐收藏还是管理更让人赏心悦目，大幅提升音乐收藏的趣味。

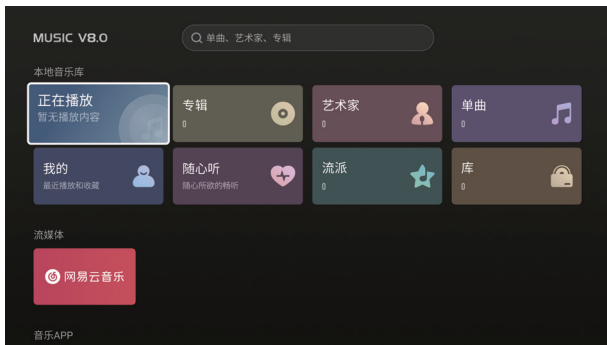

3.1 本地音乐库添加操作指引

- ① 音乐播放器首页进入“库”；
- ② 选中并点击“添加曲库”；
- ③ 选择一个音乐目录（支持添加多个目录），路径支持内外置存储、SMB、NFS 等，选好后点击确认完成；
- ④ 最后等待音乐播放器加载完成即可。

3.2 CD 音乐播放

Z30 PRO 通过外挂 USB 移动光驱，支持音乐 CD 光盘的播放。

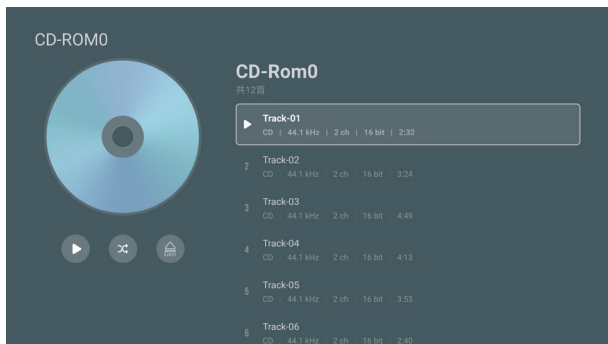

3.3 音乐播放器设置介绍

进入指引：音乐播放器首页下拉至底部进入设置菜单。

播放：播放菜单里面有专辑跳曲播放、文件夹跳曲播放、播放列表跳曲播放、开机自动播放队列、起播时跳转到播放界面等功能。

扫描：扫描菜单里面有匹配方式、优先本地图片、不扫描500kb以下的歌曲、自动更新设备、扫描音乐格式等功能。

显示：显示菜单里面有显示播放详情背景图功能。

通用：通用里面有备份与还原、重置音乐库、清除缓存等功能。

4. 全部应用

显示播放器安装的全部应用，包括内置与第三方应用。选中软件按菜单键可呼出功能菜单，支持开机自启、清除数据、卸载（第三方应用）等功能设置。



5. 设置

进入指引：首页点击最右侧的 。

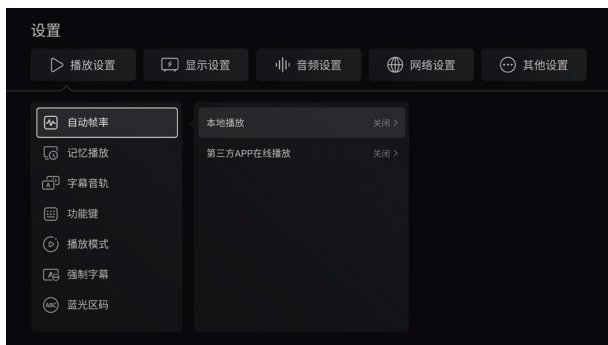

5.1 播放设置

播放设置中包括有自动帧率、记忆播放、字幕音轨、功能键、播放模式、强制字幕、蓝光区码、字幕下载目录、演示模式等功能。

自动帧率介绍

ZIDOO 媒体播放器本地与第三方 APP 在线播放均支持精准的原始分辨率和帧率 (支持 23.976, 24, 25, 29.97, 30, 50, 59.94, 60) 自动切换输出, 采用新的自动切换算法机制, 让影片在播放前完成预先切换, 保证了影片呈现的完整性, 不错过任何观影细节。

芝杜支持本地播放与 " 第三方 APP 在线播放 " 的自动帧率设置, 您可以选择 " 关闭自动帧率 "; 也可选择 " 匹配帧速率 ": 播放视频时, 播放器会自动切换与片源相同的帧率; 还可选择 " 匹配帧速率与分辨率 ": 播放视频时, 播放器会自动切换与片源相同的分辨率与帧率。

注意: 打开此开关, 在开始播放与结束播放视频时, HDMI 需要重新握手, 此时显示设备将黑屏几秒。

5.2 显示设置

显示设置中有分辨率、颜色设置、HDR、自定义 EDID、屏幕缩放、图像调节、AI 画质处理、UI 界面分辨率、屏保、壁纸等功能设置。

① 颜色设置介绍

设置播放器8K、4K、低于4K分辨率优先输出色彩空间与色彩深度以及HDMI信号格式。HDMI格式可设置为标准格式与增强格式。

注意:

* 当您选择增强格式时, 若您的显示设备支持, 将可实现最高8K 422 12bit的输出。

* 请确保您使用了支持48G带宽且质量良好的HDMI线材。

② HDR设置介绍

- UI界面显示模式：设置UI的显示模式，SDR、HDR、DV三个模式可选。
- HDR输出模式：

自动：播放器根据片源与显示设备支持能力，自适应输出最佳图像模式。

杜比视界输出模式：当显示设备同时支持TV Led与LLDV杜比视界模式时，此选项会出现在菜单并支持自定义切换；显示设备仅支持TV Led或LLDV其中一种杜比视界模式时，此选项将隐藏并由播放器自适应输出；显示设备不支持杜比视界时，此选项自动隐藏且不生效。

高级设置：高级模式可将不同的内容根据需要转换至另一种格式输出，并且可以将VS10杜比画质引擎根据内容自定义介入。此功能为专业用户提供更多的灵活性，普通用户设置成自动即可。

HDR 高级设置

视频模式	输出模式选项
SDR 内容输出模式	SDR（默认）、HDR、DV
HDR10 内容输出模式	SDR、HDR（默认）、DV
HDR10+ 内容输出模式	SDR、HDR、HDR10+（默认）、DV
HLG 内容输出模式	SDR、HLG（默认）、DV
杜比视界内容输出模式	SDR、HDR、DV（默认）
对 SDR 视频使用 Dolby VS10	是、否（默认）
对 HDR10 视频使用 Dolby VS10	是、否（默认）
对 HDR10+ 视频使用 Dolby VS10	是、否（默认）
对 HLG 视频使用 Dolby VS10	是、否（默认）
对 DV 视频使用 Dolby VS10	是、否（默认）

③ AI画质处理介绍

- AI画质增强：通过人工智能识别内容场景，针对不同场景逐帧调校画面的色彩饱和度、亮度、锐利度、动态补偿以及智能降噪，进而提升整体画质。
- AI超分辨率：通过升频技术及深度学习功能实现图像超分辨率，能够智能地提升来自流媒体、有线电视以及光盘中呈现的内容分辨率，让画面更清晰。结合MEMC动态补偿，可以提供更精彩的4K观影体验。

注意：AI画质增强仅针对1080P与1080P以下视频并且当前输出高于1080P时生效，打开此选项时请关闭“匹配帧速率与分辨率”功能。

5.3 音频设置

音频设置包括音频输出、HDMI 输出、光纤同轴输出、USB 音频输出等高级设置。

① 音频输出介绍

- 音频输出：本机内置播放器解码播放音视频。支持HDMI、光纤/同轴、USB音频输出。

数字端口	输出能力
HDMI 输出	最高支持 Dolby Atmos、DTS-X 并向下兼容
光纤 / 同轴	支持 DD/DTS5.1，音频采样率最高支持 PCM192Khz
USB 音频输出	最高支持 DSD512 / PCM768Khz 32bit

- 延时播放功能说明：

当HDMI输出、光纤/同轴连接AV前级以及USB连接前级时，采样率发生变化时因前级的音频识别速度会导致曲目的前几秒无声，此选项可设置延时播放避免这种情况，请根据你的前级的反应速度调整合适的延迟时间。

注：此功能仅对纯音频生效，支持0-5000ms的延迟调节。

5.4 网络设置

网络设置：可进行无线网络、有线网络、蓝牙、Samba 服务、无线热点等功能设置。

5.5 其它设置

其他设置包括有语言、HDMI CEC、电源模式、硬盘休眠、前显示面板、输入法、日期与时间、整点报时、主界面天气、升级、恢复与重置、关于等高级功能设置。

- HDMI CEC介绍

CEC，全称是Consumer Electronics Control，消费类电子控制，CEC控制就是通过HDMI进行控制传导的一种手段。CEC功能为用户带来许多方便，它允许终端用户使用一个遥控器控制多个支持CEC的设备，从而无需使用多个遥控器来控制电子设备，如：电视机(TV)、机顶盒等。

HDMI CEC	功能介绍
当电视开机时启动播放器	---
当电视关机时关闭播放器	---
当播放器开机时启动电视	---
当播放器关机时关闭电视	---
电视遥控器控制播放器	电视遥控器上下左右导航键、确定键、菜单键以及返回键可以控制播放器
播放器控制电视音量	当 HDMI 音频设置源码透传时，芝杜遥控器音量键控制电视音量
播放器控制 AVR (功放或回音壁) 音量	当 HDMI 音频设置源码透传时，芝杜遥控器音量键控制 AVR (功放或回音壁) 音量
HOME 键，一键播放	电视同时有多个信源输入且电视当前不在芝杜信源时，按一下芝杜遥控器主页键电视会自动切换至芝杜信源
当电视切换到其他 HDMI 口时关闭播放器	电视同时有多个信源输入且电视当前在芝杜信源时，电视切换到其他信源自动关闭播放器

注意：

* 当HDMI为源码输出时，此功能将把本机音箱控制信号通过CEC发送至功放或电视等设备，使用此功能时请确保其他设备已打开CEC。此功能有可能会产生兼容问题，不是所用的设备都能受控。

遥控器颜色键功能定义

1. 进入指引：按遥控器任意未定义颜色键或从全部应用打开功能键；

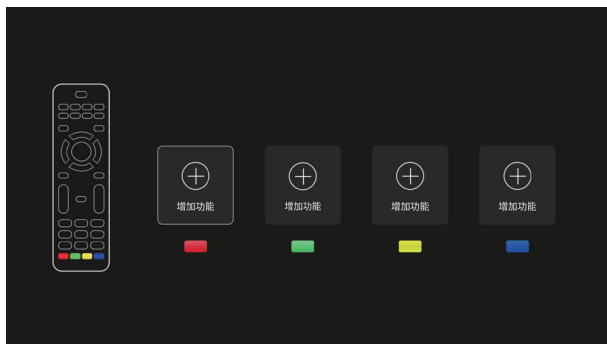

2. 该功能可将遥控器红、绿、蓝颜色键自定义为某个功能快捷按键；支持音乐播放队列、音乐正在播放、AI画质处理等自定义，全局一键呼出。



OTA 系统升级

芝社会不定期更新固件，在应用中心找到系统升级图标点击打开；支持在线网络升级与本地升级两种方式；勾选自动检测在线升级后，您将会收到最新的系统升级提示。

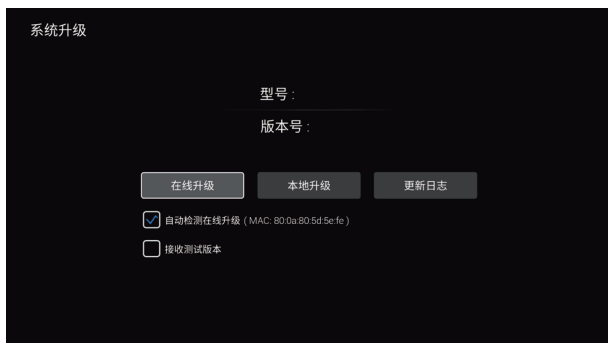

1. 在线升级

点击“在线升级”选项，获取在线升级信息后即可进行升级。



2. 本地升级

① 用户可通过在论坛或官网手动下载升级文件，通过本地升级的方式自行升级系统。将下载好的升级文件拷贝到U盘（无需解压），通过点击“本地升级”选项，选择升级文件。



② 通过在线升级或本地升级下载完升级文件后，系统会自动校验系统文件完整性并开始升级。

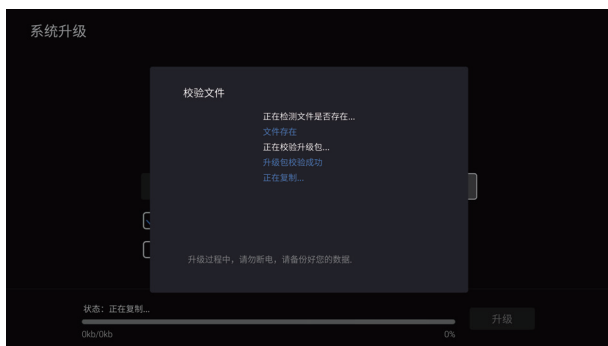

注意：自动进入系统升级，该过程请不要断电。

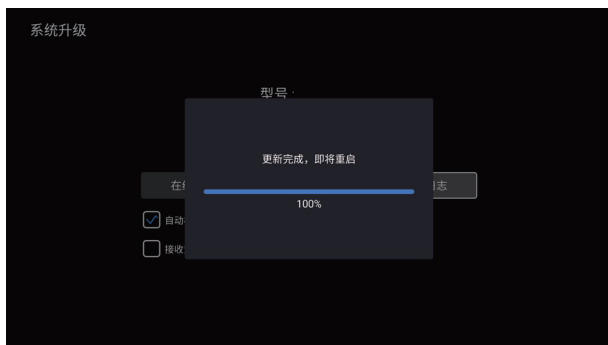

升级完成，自动重启系统。

特别说明：

为了保证用户体验，芝杜 ZIDOO 会不定期更新固件，因此，本说明书的操作说明，有可能会与产品实际使用情况稍有出入，请以实际情况为准。

安全警示：

1. 本设备不得遭受水溅或水滴，不得在设备上放置类似花瓶一类装满液体的物品。
2. 本产品断开装置为电源插座，配备给本产品使用的插座应当装在本产品附近，且应当便于操作，不能被其他物体阻挡。
3. 本产品为 II 类设备，使用时机箱内部必须要有接地措施。

Introduction to Hardware

Interfaces

The ZIDOO Z30 PRO is equipped with a wide range of audio and video input/output interfaces and data transfer ports.

1. Front

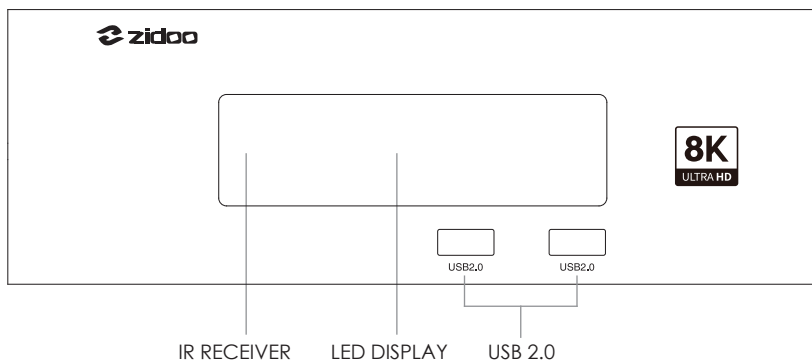

2.Left

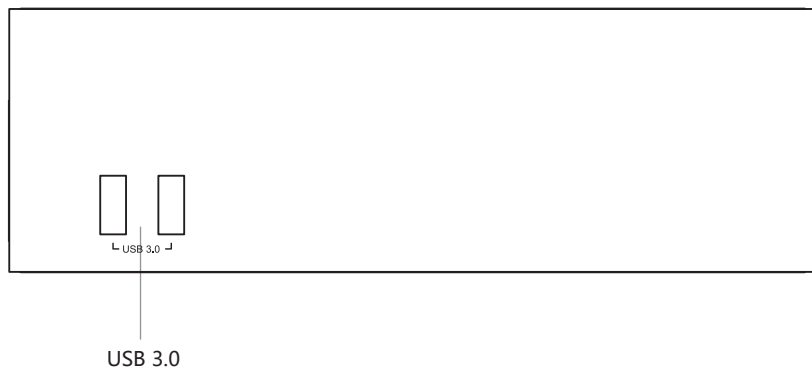

3. Right



HDD BAY

4. Back

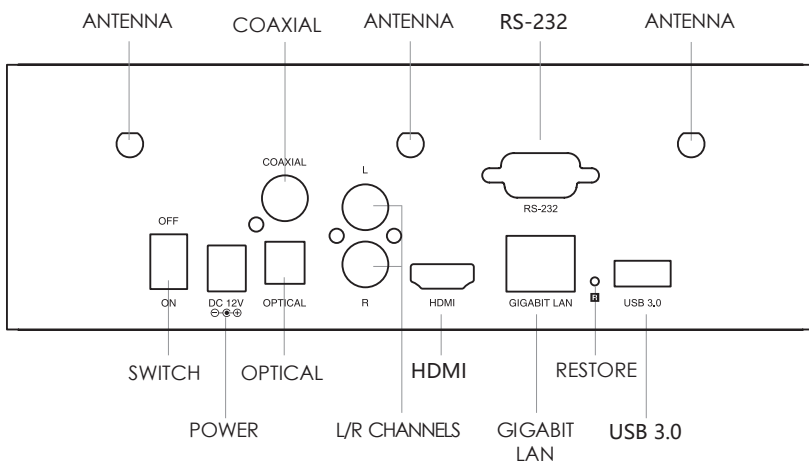

Antenna Installation Instruction: Please install the three antennas from the accessories onto the antenna interfaces shown in the image above.

Notes:

- * Please install/replace the hard disk when the power is off. If it is a brand new hard disk, please format it before installing.
- * Do not cover any ventilation holes with any objects.
- * Avoid contact with liquids to prevent damage to the internal components.
- * Do not open the casing unless you are an authorized repair personnel.

Specifications

Front Display	LED
Chassis Material	Aluminum Alloy
OS	Android 11
CPU	Amlogic S928X-K ARM Cortex-A76+Cortex-A55 (Quad-core)
GPU	ARM Mali-G57 MC2
RAM	6GB DDR4
Internal Storage	64GB eMMC
Bluetooth	BT 5.2
WI-FI 6	2.4G+5G dual-band Wi-Fi, 802.11 a/b/g/n/ac/ax 2T2R, 802.11ax MIMO OFDM
Ethernet	RJ-45 Ethernet jack*1 (10/100 /1000Mbps)
HDMI Out	HDMI 2.1a, supports up to 8K@60p, HDR10+, 12Bit color depth, BT2020 wide color range; Supports HDR10, HDR10+, HLG, Dolby Vision; Supports Dolby Atmos and DTS X audio pass-through
Video Decoding	8K@60p AV1/VP9/H.265/AVS3/AVS2; HDR10, HDR10+, HLG, Dolby Vision
Audio Decoding	Supports Dolby/DTS format (up to Dolby TrueHD Atmos and DTS X) decoding
Audio Output	USB output, Optical output*1, Coaxial output*1, RCA L/R channel output*1
Intelligent Control	APP control for iPhone, iPad landscape mode, Android phone, Android tablet landscape mode, RS-232, TCP/IP control (supports WOL)
SATA	One built-in 3.5' ' HDD bay with SATA 3.0 specification (HDD not included)
USB	USB 3.0*3, USB 2.0*2
Power Supply	DC 12V 2A
Other interface	Infrared receiver*1, RS232*1, antennas*3

Hard Disk Installation

The Z30 PRO has one 3.5-inch HDD bay with built-in high-speed SATA transfer interfaces. Please slowly push the hard disk with SATA interface facing inward to install, no tools are needed (the maximum supported hard disk capacity is 16TB).

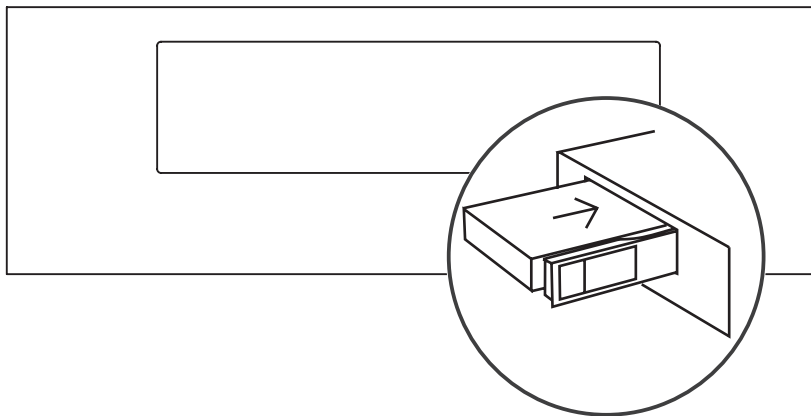

Note: Do not load or replace the hard disk while the device is powered on to avoid damage to the device or hard disk data. Brand new hard disks need to be formatted before loading. This device supports the following hard drive formats: EXT3, EXT4, NTFS, FAT32, EXFAT.

Example Connection

1. HDMI Connects to TV

1) Cut off the power of the devices. Please make sure the power of both the TV and this media player are off.



2) With both the TV and media player powered off, insert one end of the HDMI cable into the HDMI port of this device and the other end into the HDMI IN port of the TV.



HDMI

3) Power connection: This device is equipped with suitable DC power adapter. Please connect the head of DC power adapter to the DC power input port of this device, then insert the plug of DC power adapter into the alternating current socket of 110~240V.

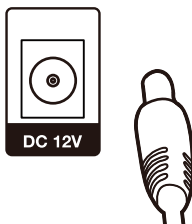

4) Select the corresponding video source on the TV.

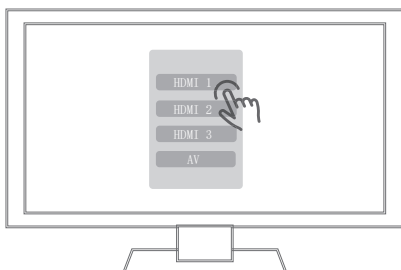

2. Other Connections

Other connection methods follow the same steps as connecting with an HDMI cable. Please connect the cables first before powering on.

Boot Initialization Wizard

1. System Language Selection, Screen Zoom, Time Zone Setting

Choose the system language.

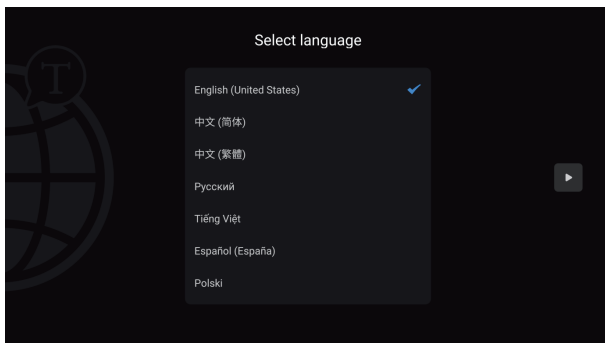

Press the UP and DOWN buttons on remote control to adjust screen display area.

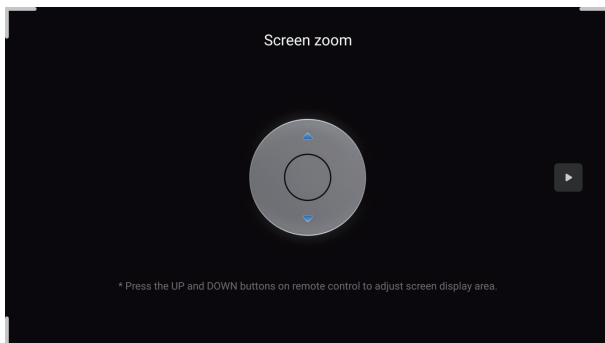

Select the time zone for the system according to your location.

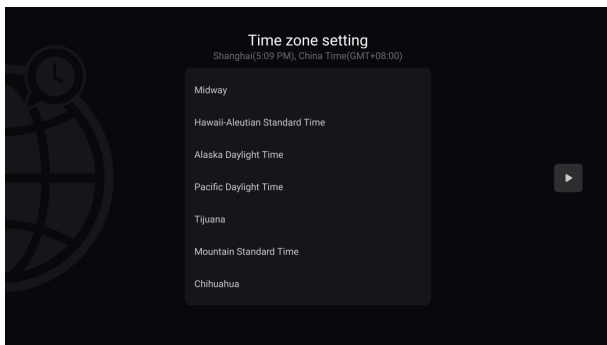

2. Network Setting

Please configure the network settings according to the specific network conditions.

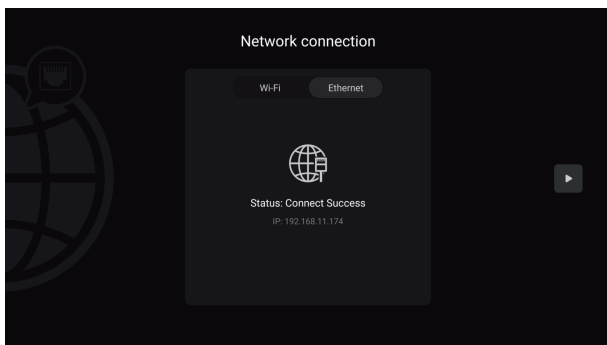

Wi-Fi: Select the network SSID, enter the password, and connect to Wi-Fi.

Ethernet: Plug in the Ethernet cable to automatically connect to the network.

3. Device Connection Methods

Choose the corresponding connection method based on your audio and video equipment.

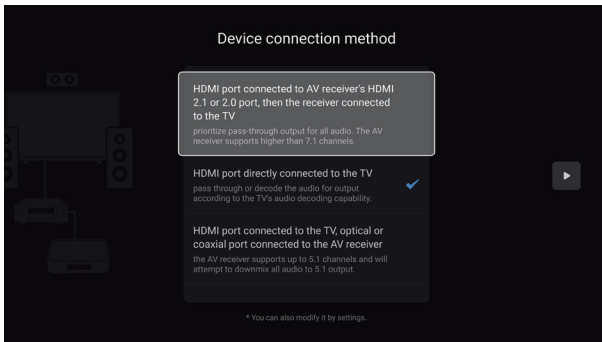

Note: The effects presented will vary depending on the different connection methods.

- HDMI port connected to AV receiver's HDMI 2.1 or 2.0 port, then the receiver connected to the TV: Choosing this setup, Z30 PRO will prioritize pass-through output for all audio. The AV receiver supports higher than 7.1 channels.

- HDMI port directly connected to the TV: Choosing this setup, Z30 PRO will pass through or decode the audio for output according to the TV's audio decoding capability.

- HDMI port connected to the TV, optical or coaxial port connected to the AV receiver: Choosing this setup, the AV receiver supports up to 5.1 channels and will attempt to downmix all audio to 5.1 output.

- HDMI port connected to an AV receiver with HDMI version lower than 1.3, then the AV receiver connected to the TV: Choosing this setup, Z30 PRO will attempt to downmix all audio to 5.1 output.

4. The Key Definition

Define the corresponding functions for number keys, timing keys, subtitle keys, audio keys, up and down keys and page keys on the remote control according to your preference.

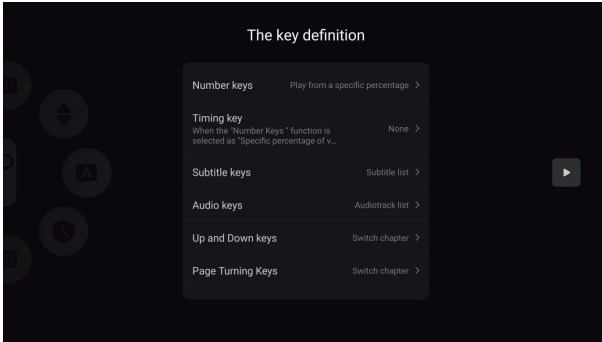

5. Phone Control

Scan the QR code on the left to download and install the ZIDOO Control App, then launch the ZIDOO Control App to scan the QR code on the right and pair with the ZIDOO media player.

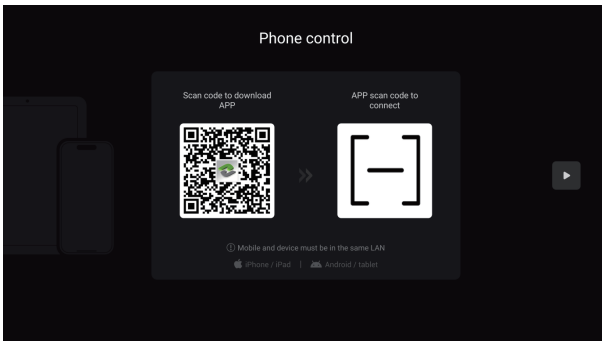

After completing the above settings, follow the prompts to click "Next" to complete the initialization setup, and then you can enjoy the audiovisual feast brought to you by ZIDOO products.

The ZIDOO Control App is compatible with Android and iOS smartphones/tablets (landscape mode). You can view the poster wall, music library data, system applications, and menus on it. You can also browse and play built-in streaming media services through the control app, enjoying a comfortable control experience.

The ZIDOO Control App supports screen mirroring, allowing you to cast the player's display screen and perform various controls on phones/tablets.

ZIDOO supports pure music mode: even without turning on the display device, you can still enjoy high-definition lossless music.

The ZIDOO Control App can remotely power on/off: it supports Wake-on-LAN (WOL) function, allowing you to remotely control the player's power switch via wired network.

The ZIDOO Control App has a floating button function, allowing you to perform various basic control functions through the floating window.

Introduction to System

1. Media Center

ZIDOO has a complete full-featured media center, which has rich and comprehensive file management functions.

- Supports direct access to external drives and automatic or manual scanning of all available NFS or SMB network drives within the local area network, providing more flexible access to media in the same LAN.
- Offers various file management methods such as multi-selection, copy, cut, delete, sort, etc.
- Supports UPnP local network sharing protocol as well as mounting and online playback of various cloud drives such as WebDAV.

2. Poster Wall

ZIDOO is equipped with a poster wall movie management system that adopts a new algorithm, featuring a simple but effective navigation interface, personalized classification based on data, and highly customizable display of viewing records, genre classifications, intelligent recommendations, and more. The highly customizable modular management greatly improves the convenience of movie collection, fully meeting users' needs for efficient management of a large number of movies.

Instructions for adding videos:

- ① When launching the poster wall for the first time, you can configure language and child lock settings. If not needed, you can skip this step.

- ② On the homepage of the poster wall, click "Open Sources."
- ③ Click "Add Source" and select a video folder (supports adding multiple folders). The path supports internal and external storage, SMB, NFS, etc.
- ④ After configuring the scan options, click "Start Scan" and wait for the poster wall to finish loading.

Note: It is recommended to use intelligent scraping sources for the poster wall.

3. Music Player

The Z30 PRO music player provides powerful local music playback performance and management functions, allowing you to add music files from local hard drives or network storage across platforms. The music player automatically retrieves music information, matches music artists, album covers, local CUE files, etc., to construct an exclusive music database for us. It supports personalized classification display of music genres, sampling rates, albums, artists, etc., and supports functions such as creating favorite playlists.

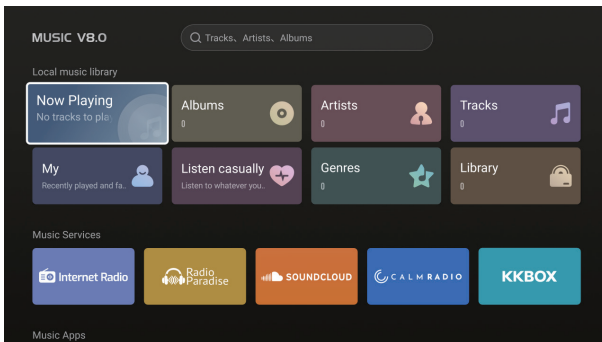

3.1 Instructions for Adding Music to Local Music Library

- ① Go to the "Library" section on the music player's homepage.
- ② Select and click on "Add Library".
- ③ Choose a music folder (supports adding multiple folders), with paths supported from internal and external storage, SMB, NFS, etc. After selecting, click "OK".
- ④ Finally, wait for the music player to finish scanning.

3.2 CD Playback

The Z30 PRO supports the playback of CDs via an external CD-Rom.

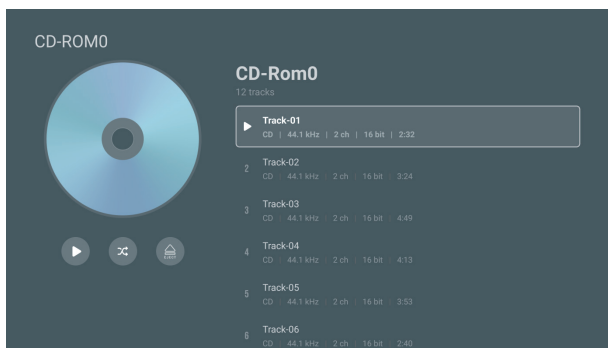

3.3 Music Player Settings Introduction

Access Guide: Pull down to the bottom of the homepage of the music player to enter the settings menu.

Play: The play menu includes features such as album skipping playback, folder skipping playback, playlist skipping playback, auto-play queue on startup, and entering to the playback interface once start playing.

Scan: The scan menu includes features such as matching method, prioritizing local images, not scanning songs under 500kb, automatic updating sources, and scanning music formats.

Display: The display menu includes features of displaying playback details with a background image.

General: The general menu includes features such as backup and restore, resetting the music library, and clearing the cache etc.

4. Applications

Display all installed applications on the player, including built-in and third-party applications. By pressing the App icon, you can bring up the function menu, which supports settings such as launch on start-up, clear data, and uninstall (third-party applications).

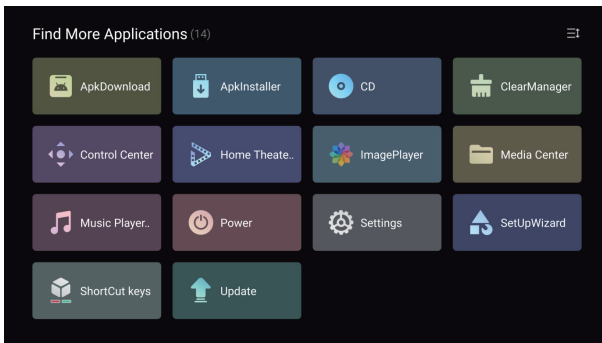

5. Settings

Access Guide: On the homepage, click the "  " icon on the far right.

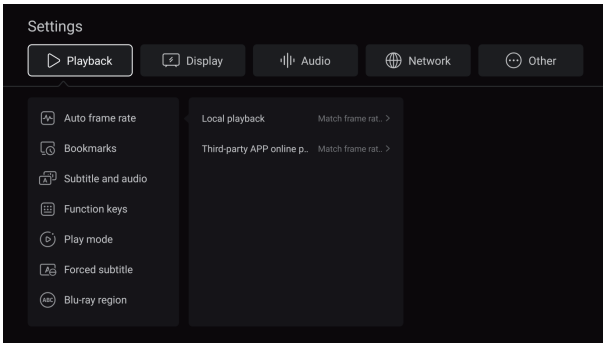

5.1 Playback

The playback settings include features such as auto frame rate, bookmarks, subtitles and audio, function keys, playback mode, forced subtitle, Blu-ray region, subtitle download, digital signage mode, and other functionalities.

Auto Frame Rate

ZIDOO media players support precise automatic switching of native resolution and frame rate (support 23.976, 24, 25, 29.97, 30, 50, 59.94, 60) for both local and third-party app online playback. It uses a new automatic switching algorithm that completes the pre-switching before the movie starts, ensuring the completeness of the movie presentation.

ZIDOO supports auto frame rate settings for both "local playback" and "third-party app online playback." You can choose to turn off auto

frame rate; Alternatively, you can select "match frame rate only", when playing a video, the player will automatically switch to the same frame rate as the source. Additionally, you can choose "match frame rate and resolution", when playing a video, the player will automatically switch to the same resolution and frame rate as the source.

Note: Enabling this option will require HDMI to re-handshake at the start and end of video playback, causing the display device to go black for a few seconds.

5.2 Display

In the display settings, there are options for resolution, color settings, HDR, custom EDID, screen scale, picture parameters, AI image process, UI interface resolution, screensaver, wallpaper, and other function settings.

① Color Settings

Set the player's color space and color depth priority for output at 8K, 4K, and below 4K resolutions, as well as the HDMI signal format. The HDMI format can be set to either Standard or Enhanced format.

Notes:

- * When you select the Enhanced format, if your display device supports it, you will be able to achieve a maximum output of 8K 422 12-bit.
- * Please ensure you are using a high-quality HDMI cable that supports 48G bandwidth.

② HDR Settings

- UI Display Mode: The UI display mode can be set to one of three options: SDR, HDR, or DV.

- HDR Output Mode:

Auto: The player adapts to output the optimal image mode based on the source and the display device's capabilities.

Dolby Vision Output Mode: When the display device supports both TV-led and LLDV Dolby Vision modes, this option will appear in the menu and allow for custom switching. If the display device supports only either TV-led or LLDV, this option will be hidden and the player will automatically adapt its output. If the display device does not support Dolby Vision, this option will automatically be hidden and will not be functional.

Advanced Settings: Advanced mode allows different types of content to be converted to another format as needed. Additionally, the VS10 Dolby Vision engine can be customized to engage based on the content. This feature provides professional users with greater flexibility, while regular users can set it to automatic.

HDR Advanced Settings

Video Format	Output Mode
SDR Content Output Mode	SDR (default) ,HDR,DV
HDR10 Content Output Mode	SDR,HDR (default) ,DV
HDR10+ Content Output Mode	SDR,HDR,HDR10+ (default) ,DV
HLG Content Output Mode	SDR,HLG (default) ,DV
DV Content Output Mode	SDR,HDR,DV (default)
Dolby VS10 for SDR Content	Yes,No (default)
Dolby VS10 for HDR10 Content	Yes,No (default)
Dolby VS10 for HDR10+ content	Yes,No (default)
Dolby VS10 for HLG Content	Yes,No (default)
Dolby VS10 for DV Content	Yes,No (default)

③ AI Image Process

- **AI Image Enhancement:** Using artificial intelligence to identify the content scene and adjust the color saturation, brightness, sharpness, dynamic compensation, and intelligent noise reduction of the picture frame by frame according to different scenes, thereby enhancing the overall image quality.
- **Enable AI SR(super-resolution):** By utilizing upscaling technology and deep learning capabilities to achieve image super-resolution, it can intelligently enhance the resolution of content presented from streaming media, cable TV, and discs, making the picture clearer. Combined with MEMC dynamic compensation, it can provide a more spectacular 4K viewing experience.

Note: AI image enhancement only applies to videos with 1080P resolution or lower and is effective when the current output is higher than 1080P. Please disable the "Match frame rate and resolution" feature when enabling this option.

5.3 Audio Settings

● **Audio Output:** Decode and play audio and video using the internal player. Support HDMI output, Optical/Coaxial output, and USB audio output.

Digital Ports	Output Capability
HDMI output	Supports Dolby Atmos and DTS-X, with downward compatibility
OPT/COAX	Supports DD/DTS5.1, audio sample rate support up to PCM192Khz
USB Audio Output	Supports up to DSD512 / PCM768Khz 32bit

● Delay Playback

When the HDMI port, Audio port, OPT/COAX connection to the AV preamp, and USB connection to the preamp are connected, changes in the sampling rate can cause the first few seconds of the track to be silent due to the audio recognition speed of the preamp. This option can be set to delay playback to avoid this situation. Please adjust the appropriate delay time according to the response speed of your preamp.

Note: This feature only applies to pure audio, supporting delay adjustment from 0 to 5000ms.

5.4 Network Settings

This menu supports settings for Wi-Fi, Ethernet, Bluetooth, Samba server, portable hotspot, and other functions.

5.5 Other Settings

This menu includes advanced settings such as language, HDMI CEC, power mode, HDD sleep, fan control, front display panel, keyboards, date and time, show hourly time, main interface weather, upgrade, recovery and reset, and about, etc.

● HDMI CEC

CEC, short for Consumer Electronics Control, is a means of control conducted through HDMI. CEC control allows users to enjoy many conveniences by using a single remote to control multiple CEC-enabled devices such as TVs, set-top boxes, etc.

HDMI CEC	Function Introduction
TV wakes up the Media Player	---
TV turns off the Media Player	---
Media Player wakes up TV	---
Media Player turns off TV	---
TV remote controls Media Player	The direction keys, OK key, menu key, and return key on the TV remote control can be used to control the media player
Media Player controls TV volume	When the HDMI audio settings are set to pass-through, the volume keys on the ZIDOO remote control will control the TV volume
Media Player controls AVR volume	When the HDMI audio settings are set to pass-through, the volume keys on the remote control of the ZIDOO will control the AVR volume
One Touch Play of Home key	When the TV has multiple signal sources input and is not currently on the ZIDOO source, pressing the ZIDOO remote's home key once will automatically switch the TV to the ZIDOO source
Inactive source turns off Media Player	When the TV has multiple signal sources input and is currently on the ZIDOO source, switching the TV to another source will automatically close the media player

Note:

*When HDMI is set to pass-through output, this function will send the control signal of the local speaker through CEC to the AV receiver or TV and other devices. Please make sure that other devices have CEC enabled when using this function. This function may have compatibility issues, and not all devices can be controlled.

Color Keys Customization

1. Access Guide: Press any undefined color key on the remote control or open the Shortcut keys from all applications.

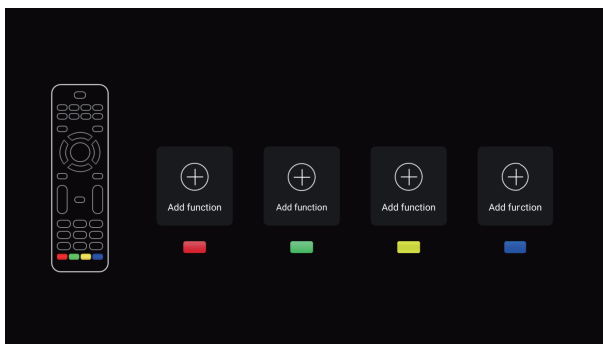

2. This function allows you to customize the remote control's red, green, and blue color keys as shortcuts for specific functions; supports customization such as music play queue, music now playing, AI image process, etc.

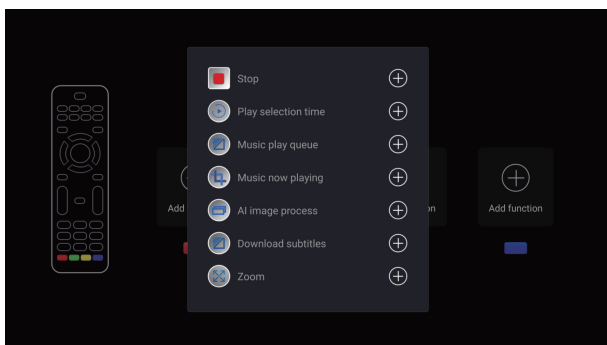

OTA System Update

ZIDOO will update the firmware from time to time.

Find the update icon in APPs and click it, online update and local update are supported. After ticking "Automatically check online upgrade" , you will receive the prompt for the latest firmware update automatically.

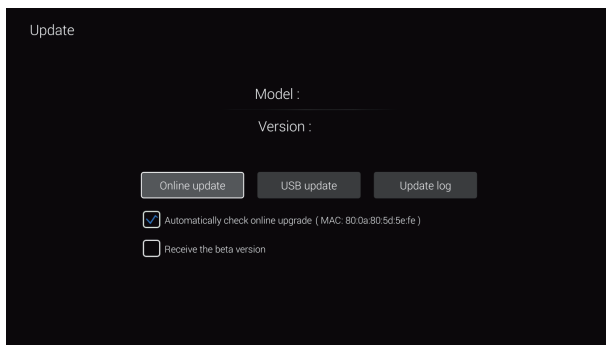

1. Online Update

Click the "Online Update" option to receive online update information and proceed with the update.

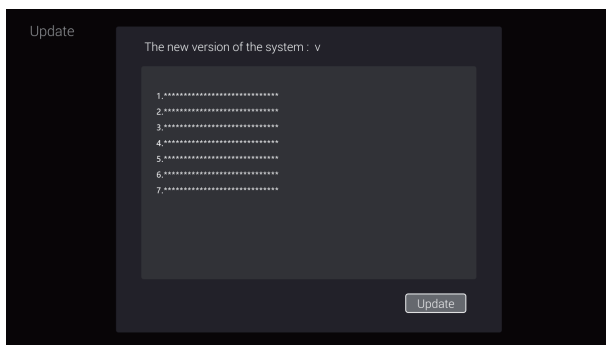

2. Local Update

① Users can manually download the update file from the forum or official website and update the system locally. Copy the downloaded update file to a USB drive (no need to unzip it), and then click the "USB Update" option to select the update file.

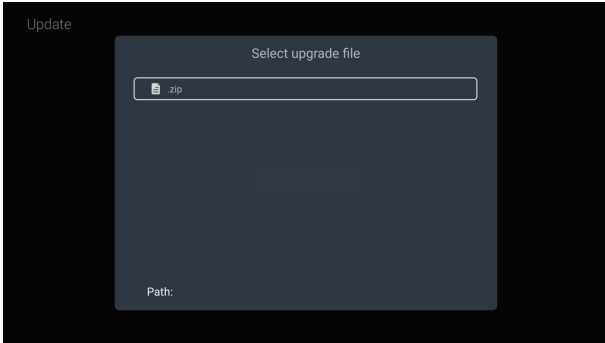

② After downloading the update file via online or USB Update, the system will automatically verify the integrity of the system file and begin the update.

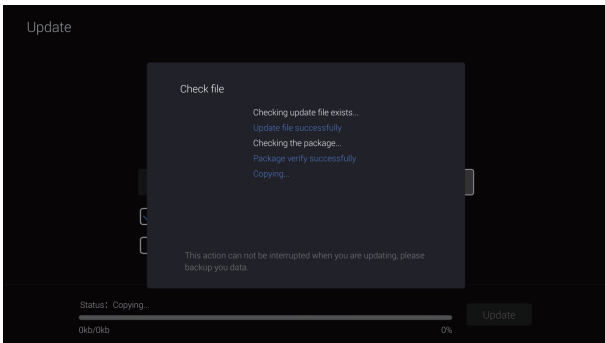

Note: System will update automatically, please do not power off.

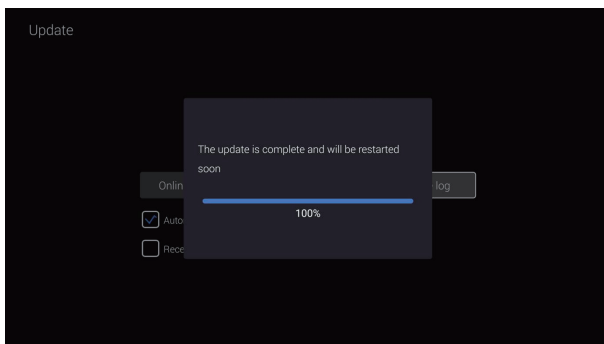

Once the update is completed, the system will automatically be restarted.

Special note:

To guarantee user experience, ZIDOO will update the firmware occasionally. Therefore, this manual may not be totally in line with the product.

Safety Warnings:

1. This device must not be exposed to splashes or drips of water, and items filled with liquids, such as vases, must not be placed on the device.
2. The AC power socket of this product is equipped with a disconnect device. The socket intended for use with this product should be installed near the product and should be easily accessible, without being obstructed by other objects.
3. This product is a Class II device, and the internal chassis must be grounded during use.

商标信息 / Trademark information

- The terms HDMI and HDMI High-Definition Multimedia Interface, and the HDMI Logo are trademarks or registered trademarks of HDMI Licensing LLC in the United States and other countries.
- HDMI 和 HDMI High-Definition Multimedia Interface 专用名词以及 HDMI 标志是 HDMI Licensing LLC 在美国和其他国家的商标或注册商标。
- Dolby, Dolby Audio and the double-D symbol are trademarks of Dolby Laboratories Licensing Corporation.
- 杜比、Dolby、Dolby Audio、和双D 符号是杜比实验室的注册商标。
- For DTS patents, see <http://patents.dts.com>. Manufactured under license from DTS Licensing Limited. DTS, the Symbol, & DTS and the Symbol together are registered trademarks, and DTS 2.0+ Digital Out is a trademark of DTS, Inc. © DTS, Inc. All Rights Reserved.
- 有关 DTS 专利，请访问<http://patents.dts.com>。由 DTS, Inc. 授权制造。DTS、标志和 DTS 连同其标志是 DTS, Inc. 的注册商标，DTS 2.0+ Digital 是 DTS, Inc. 的商标，© DTS, Inc. 版权所有。



400-180-9091

www.zidoo.tv